

# ELEMENT Lab Bench

EFFICIENT CAPABILITY



SEFA 10 CLASS 7 & 8

SEFA 10 CLASS 7 & 8

# Element Lab Bench

- Designed with your space in mind. With integrated electric and services in the uprights.
- Height adjustable, multiple circuit and service options.

## Configure Your Bench

Choose your bench either knockdown or fully assembled.

Then choose your accessories.



## FEATURES

- Data ports standard on plumbing posts
- SEFA 10, Category 3 – 1,000 pound capacity
- Ships knocked down or assembled
- Worktop height adjustable on 1" increments
- Plumbing or electric on posts available
- Integrated cable management under worktop
- Up to three fixtures per upright post
- Seismic anchoring accessories available
- Multiple standard sizes to choose from
- Listed to UL 962 Standard

# Element Lab Bench

## Element Lab Bench Part Number Explanation

# ET843672-P3SKC2GK

### Product Code

ET = Element

### Height

84 = 84" Tall

### Worktop Depth

30 = 30" Deep

36 = 36" Deep

### Worktop Length

36 = 36" Length

42 = 42" Length

48 = 48" Length

54 = 54" Length

60 = 60" Length

66 = 66" Length

72 = 72" Length

### Power Options

P0 = None

P1 = Left

P2 = Right

P3 = Both\*

\*(Both Legs Will Receive Same Circuit Selection)

### Shipping

Knockdown = K

Assembled = A

### Feet

Stabilizing Casters = C

Glides = G

### Circuits

No Electric = C0

All 4 on 1 Circuit = C1

Dual Circuit on (1) Power Cord = C2

Dual Circuit on (2) Power Cords = C3

### Electrical Outlet Color

No Electric = 0

Black = K

Ivory = V

White = W

Grey = G

Red = R

### Electrical Grade

No Electric = 0

Spec = S

Hospital = H

### Circuit Layouts



Circuit 1



Circuit 2

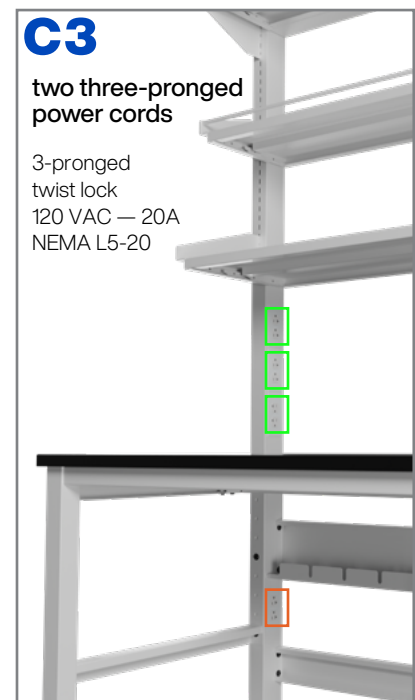
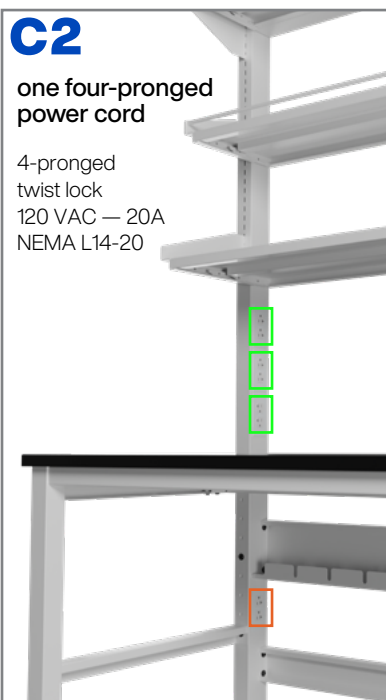
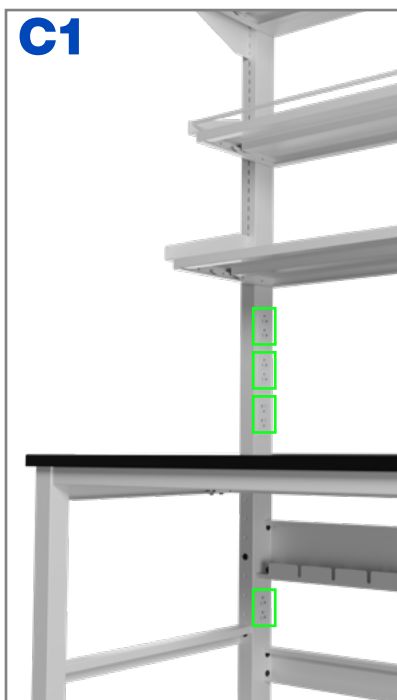













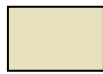
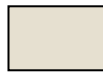

# Element Lab Bench



Shown above is an assembled bench with top.

Bench = **ET843060-P3SWC1GA**  
Resin Top = **BB84R013060-BK**

Available in Kewaunee's standard metal paint colors.

			
<b>12</b> Black	<b>463</b> Iron Ore	<b>242</b> Flint Grey	<b>85</b> Satin Grey
			
<b>94</b> True Blue	<b>20</b> Sand Tan	<b>61</b> Light Neutral	<b>78</b> Snow White
			
<b>103</b> Smokey Blue	<b>90</b> Amazon	<b>102</b> Agave	<b>104</b> Sage
			
<b>87</b> Mountain Blue	<b>62</b> Driftwood	<b>97</b> Invigorate	<b>99</b> Rapture Red



Integrated outlets allow for clean and simple electrical access. Three outlets above and one below the worksurface on each electrical post.

Fixtures and data available on plumbed posts.

**C = Stabilizing  
Caster**

**G = Glide**



**Minimum Height**

at Worksurface  
32" with caster  
30" with glide

at top of Uprights

86" with caster  
84" with glide

Casters rated for  
550lb each.



**Maximum Height**

at Worksurface  
38" with caster  
36" with glide

at top of Uprights

86" with caster  
84" with glide

Additional sets of feet can be  
ordered separately

Part Number	Set of
BBCAST2	4
BBGLIDE	4

# Accessories

NOTE: ACCESSORIES ARE ORDERED AND SHIPPED SEPARATELY

## Kemresin® Epoxy Resin

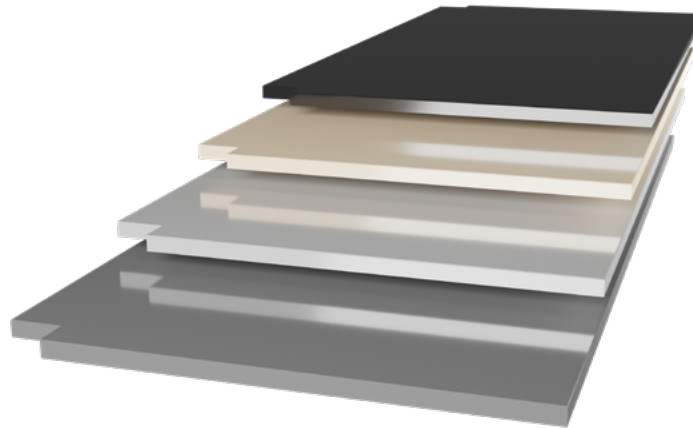

Kemresin® is perfectly suited for use in the lab setting. With ultra-smooth non-porous surface appearance, composed of 1 inch thick molded epoxy resin, these tops come in four different colors. Colors include black, grey, putty and slate.



Grey = **GR**



Slate = **SL**



Putty = **PT**



Black = **BK**

**BB84R**          -

### Part Number Depth Length

Part Number	Depth	Length
BB84R013036	30	36
BB84R013042	30	42
BB84R013048	30	48
BB84R013054	30	54
BB84R013060	30	60
BB84R013066	30	66
BB84R013072	30	72
BB84R013636	36	36
BB84R013642	36	42
BB84R013648	36	48
BB8401R3654	36	54
BB84R013660	36	60
BB84R013666	36	66
BB84R013672	36	72

# Accessories

NOTE: ACCESSORIES ARE ORDERED AND SHIPPED SEPARATELY

## UPPER SHELF

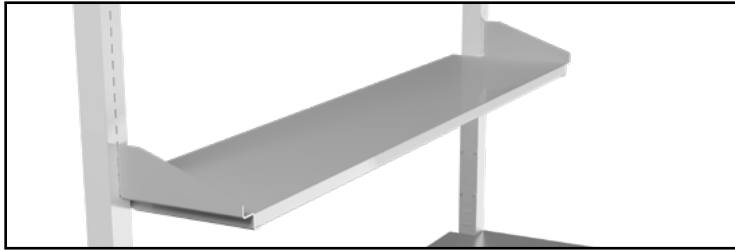

Part Number	Depth	Length	
BBEUS1236	12	36	Shelves are adjustable on 1" increments. Rear of shelves are flush with back of posts.
BBEUS1242	12	42	
BBEUS1248	12	48	
BBEUS1254	12	54	
BBEUS1260	12	60	To order Retaining Rods add <b>-ROD</b> to the end of the upper or top shelf part numbers.
BBEUS1266	12	66	
BBEUS1272	12	72	
BBEUS1536	15	36	
BBEUS1542	15	42	Rods are 3/8" powder coated steel.
BBEUS1548	15	48	
BBEUS1554	15	54	
BBEUS1560	15	60	
BBEUS1566	15	66	
BBEUS1572	15	72	Example: <b>BBUS1566-ROD</b>

## TOP SHELF

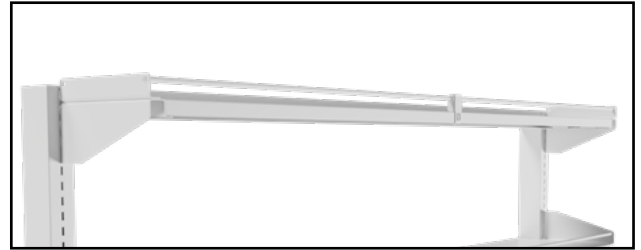

Part Number	Depth	Length	
BBETS0936	9	36	To order the Retaining Rods shown in the image, add <b>-ROD</b> to the end of the upper or top shelf part numbers. Rods are 3/8" powder coated steel.
BBETS0942	9	42	
BBETS0948	9	48	
BBETS0954	9	54	
BBETS0960	9	60	
BBETS0966	9	66	
BBETS0972	9	72	
BBETS1236	12	36	
BBETS1242	12	42	
BBETS1248	12	48	
BBETS1254	12	54	Example: <b>BBTS1566-ROD</b>
BBETS1260	12	60	
BBETS1266	12	66	
BBETS1272	12	72	
BBETS1536	15	36	
BBETS1542	15	42	
BBETS1548	15	48	
BBETS1554	15	54	
BBETS1560	15	60	
BBETS1566	15	66	
BBETS1572	15	72	

## LOWER SHELF

Part Number	Depth	Length
BBLS0936	9	36
BBLS0942	9	42
BBLS0948	9	48
BBLS0954	9	54
BBLS0960	9	60
BBLS0966	9	66
BBLS0972	9	72
BBLS1236	12	36
BBLS1242	12	42
BBLS1248	12	48
BBLS1254	12	54
BBLS1260	12	60
BBLS1266	12	66
BBLS1272	12	72
BBLS1536	15	36
BBLS1542	15	42
BBLS1548	15	48
BBLS1554	15	54
BBLS1560	15	60
BBLS1566	15	66
BBLS1572	15	72

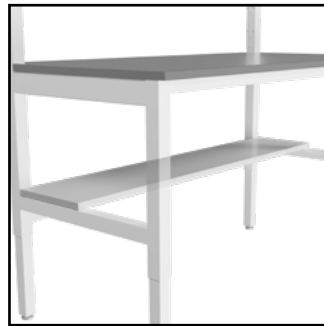

The lower shelf is installed across the bench's lower support.

## SHELF LIPS



Part Number	Length	Part Number
		Front Lip
BBFLIP36	36	BBRLIP36
BBFLIP42	42	BBRLIP42
BBFLIP48	48	BBRLIP48
BBFLIP54	54	BBRLIP54
BBFLIP60	60	BBRLIP60
BBFLIP66	66	BBRLIP66
BBFLIP72	72	BBRLIP72

# Accessories

NOTE: ACCESSORIES ARE ORDERED AND SHIPPED SEPARATELY

## SUSPENDED CABINET HANGING RAIL

Part Number	Length
BBHR36	36
BBHR42	42
BBHR48	48
BBHR54	54
BBHR60	60
BBHR66	66
BBHR72	72

Hanging rail allows for the install of Kewaunee's suspended cabinets. The rail bolts in two different positions to support different depth cabinets.

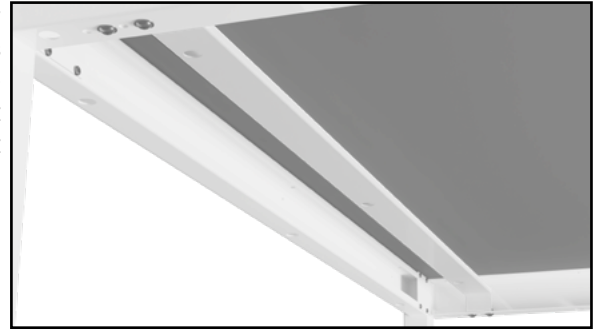

## CABINET STOP

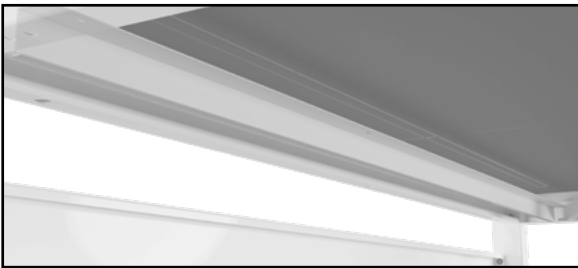

Part Number	Length
BBCABSTOP36	36
BBCABSTOP42	42
BBCABSTOP48	48
BBCABSTOP54	54
BBCABSTOP60	60
BBCABSTOP66	66
BBCABSTOP72	72

Requires cabinet hanging rail. Not compatible with CPU or Keyboard Holders.

## KEYBOARD HOLDER



Designed to hold a standard keyboard and mouse. Select 30 or 36 to match bench depth.

BBKBD-30 / BBKBD-36  
Not Compatible with Cabinet Stop.

## MONITOR ARM

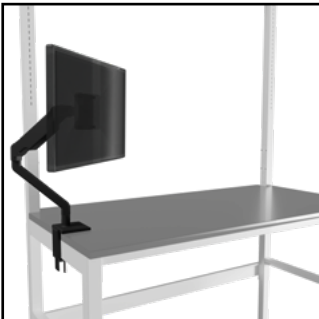

Monitor arm rotates 360 degrees at two points. With an adjustable head with universal monitor mount, arm easily clamps onto any Element Lab Bench.

BBLCDARM

## TOP RAIL DUST COVER

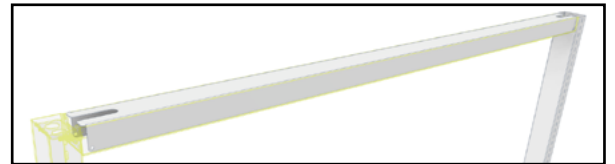

Part Number	Length
ETTC36	36
ETTC42	42
ETTC48	48
ETTC54	54
ETTC60	60
ETTC66	66
ETTC72	72

## CPU HOLDER



The CPU holder attaches via a bracket mount and swivels side to side. The heavy duty holder is adjusted 12" to 20" high and 3.5" to 9" depth. Not Compatible with Suspended Cabinets. Select 30 or 36 to match bench depth.

BBCPU-30 / BBCPU-36

Not Compatible with Cabinet Stop.

# ACCESSORIES

NOTE: ACCESSORIES ARE ORDERED AND SHIPPED SEPARATELY

## LED TASK LIGHTING



LED Task Lighting consists of a thin-profile, white, LED strip, 9.5 mm high by 33mm deep with a touch dimmer switch. It is UL listed and furnished with a 120 VAC to 24 VDC power supply with ten foot power cord. The light includes a magnetic mounting strip for mounting to steel shelving.

BBML20 & BBML40 Kits that include a power supply and power supply mounting bracket.

Part Number	Length
BBML20	20
BBML40	40

Lights listed below do not include power supplies or power supply mounting brackets. These can be purchased as replacement parts.

Part Number	Length	Fits under
X-030002-00	500mm - 19 5/8"	29" - 40" Shelves
X-030003-00	1000mm - 39 3/8"	46" - 47" Shelves

## POWER CORD

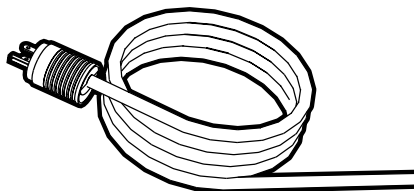

Part Number  
**ETPCC1-03B**

Circuit Type	Color
C1 = 3-Prong Plug	B = Black
C2 = 4-Prong Plug	W = White

Cord Length (above top of post)	Single-circuit 3-prong	Dual-circuit 4-prong
03 = 3'	120 VAC — 20A — NEMA L5-20	120 VAC — 20A — NEMA L14-20
04 = 4'		
05 = 5'		
06 = 6'		
08 = 8'		

## LEG ANCHOR

Part Number	Set of
BBLEGANCHORBKT	4

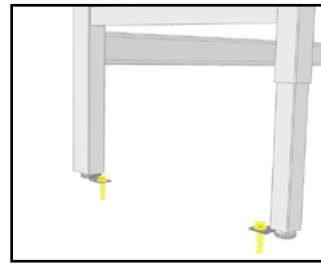

The leg anchor bracket captures the glide on each leg to prevent movement in any direction. The bracket has a mounting hole for an anchor bolt (not included).

## FIXTURES

Hose Type	Part Number	Total Length
AIR/VAC/NIT	BBFXPV046- <i>IN</i>	46"
AIR/VAC/NIT	BBFXPV096- <i>IN</i>	96"
AIR/VAC/NIT	BBFXPV0168- <i>IN</i>	168"
GAS	BBFXSP046- <i>IN</i>	46"
GAS	BBFXSP096- <i>IN</i>	96"
GAS	BBFXSP0168- <i>IN</i>	168"

-*IN* only if installed

Choose up to three fixtures per side. Fixtures can be installed on the assembled or knockdown version, as well as ordered separately.

The AIR/VAC/NIT service fixtures include PVC hose at desired length. GAS service fixtures include stainless steel hoses at desired length. Tech sheet required for installed fixtures.

Fixture and hose come preassembled terminated in a female swivel. Hoses are white as standard.



Male Quick-Connect Fitting 3/8" IPS Male

Part Number	Key Color
W-8111-K2	Orange
W-8111-K4	Yellow
W-8111-K5	Blue
W-8111-K7	Purple
W-8111-K8	Brown

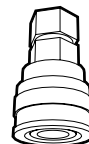

Female Quick-Connect Fitting 3/8" IPS Female

Part Number	Key Color
W-9112-K2	Orange
W-9112-K4	Yellow
W-9112-K5	Blue
W-9112-K7	Purple
W-9112-K8	Brown



# EFFICIENT STORAGE

## CASEWORK

Clearance allows for our 36" standing height, mobile, cabinets or an accessory rail for hanging suspended cabinets. Storage cabinets are available in the same standard colors as the bench, for easy color coordination.



## SHELVING

Maximize and organize lab storage by configuring shelves to meet the needs of your lab. Clear sight lines or storage capacity can be your priority, all without sacrificing your access to multiple electrical outlets.

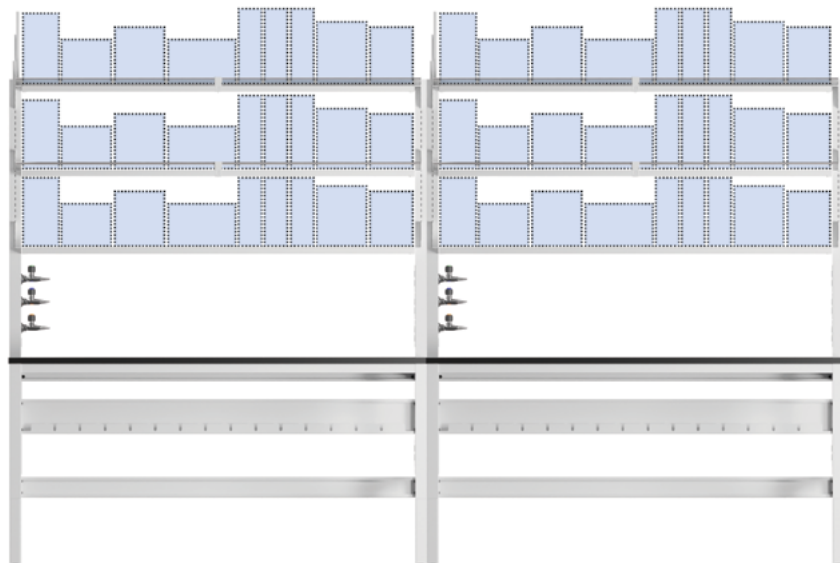

# Technical Information

## DIMENSIONAL DATA

for reference only

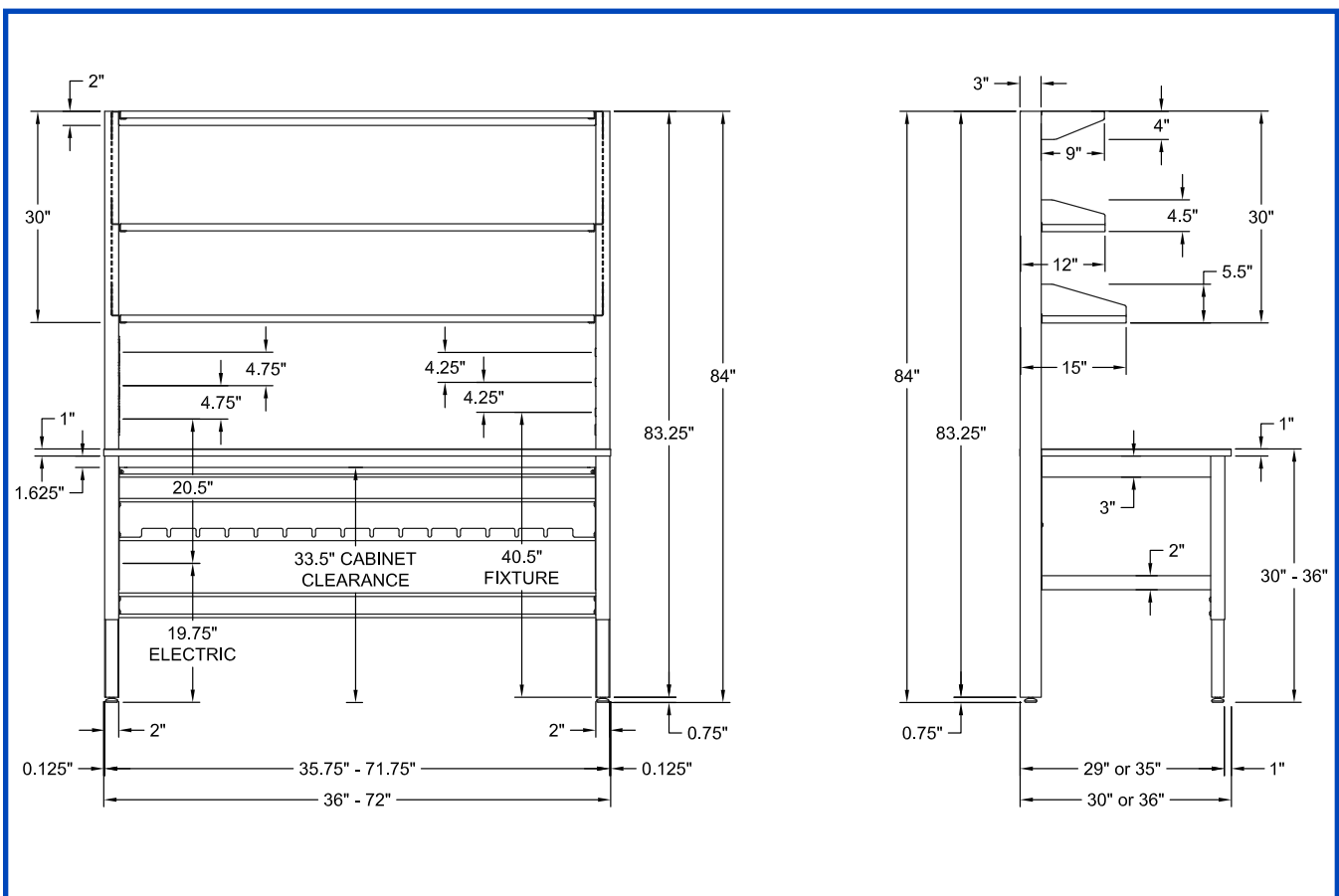

## NOTES

### Load Ratings:

MAX 1000 lbs on work surface,  
MAX 200 lbs on each shelf.

This product is intended to be used in a laboratory environment. The bench provides support for laboratory equipment and supplies electrical outlets for use in laboratory applications.

### Electrical Specs:

SJ-12-3 cord terminating at one (1) twist lock NEMA L5-20P plug at one end and one (1) circuit with one (1), two (2), three (3) or four (4) 125 V, 20 A duplex receptacles at the other end. Or alternatively, SJ-12-4 cord terminating at one (1) twist lock L14-20P plug at one end and at two (2) circuits each with one (1) or two (2) 125 V, 20 A duplex receptacles at the other end. Or alternatively, two (2) SJ-12-3 cords terminating at two (2) twist lock NEMA L5-20P plug at one end and at two (2) circuits each with one (1) or two (2) 125 V, 20 A duplex receptacles at the other end. In each circuit, the duplex receptacles may be replaced by a GFCI protected receptacle.

### Plumbing Specs:

Non-electrified post may come supplied with up to two pre-piped service fixtures. Air, Vacuum and Nitrogen fixtures can be supplied with a PVC hose at specified length, and Natural Gas fixtures can be supplied with a rated stainless steel hose at specified length. Hoses terminate at female 3/8 NPT connector. Length of plumbed hose available above the post can be found by subtracting 34.25 for top 38.5 for the middle and 42.75 for bottom locations from the total hose length above.

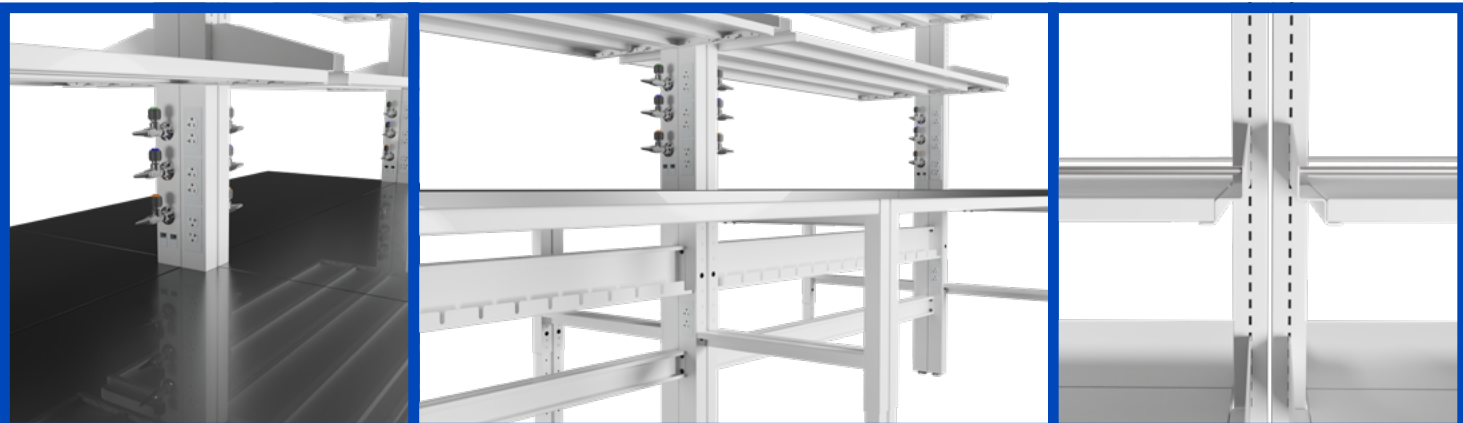

# BE IN YOUR ELEMENT

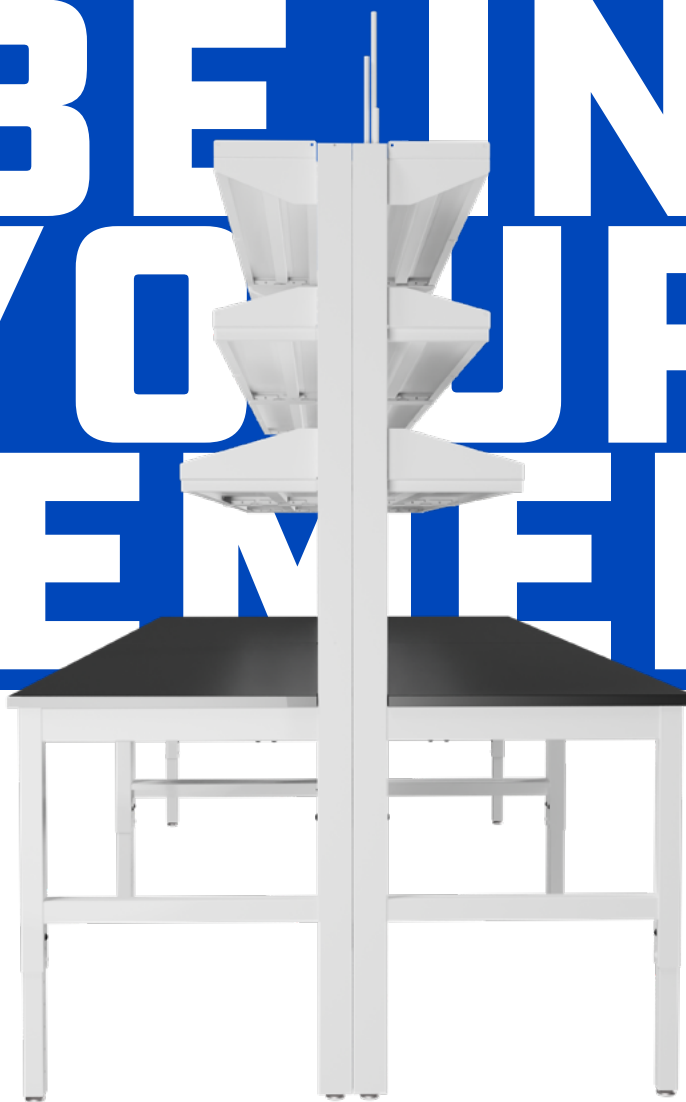

VISIT KEWAUNEE.COM TO FIND YOUR LOCAL DEALER



Kewaunee Labway India Pvt. Ltd.  
No. CA-9A, 2nd Floor, Jigani Link Road  
Jigani, Bangalore 562 106, India  
Phone: 9180-27826725 • Fax: 9180-27826724  
Web Site: [www.kewaunee.in](http://www.kewaunee.in)

P.O. Box 1842 • Statesville, NC 28687-1842  
E-mail: [kscmarketing@kewaunee.com](mailto:kscmarketing@kewaunee.com)  
Web Site: [www.kewaunee.com](http://www.kewaunee.com)

Kewaunee Labway Asia Pte. Ltd.  
194 Pandan Loop, #06-22  
Pantech Business Hub, Singapore 128 383  
Phone: 65-6773-0288 • Fax: 65-6773-2322